

PRELIMINARY
NOT FOR CONSTRUCTION

project title:

EAST MAIN STREET IMPROVEMENTS
E MAIN STREET & S 6TH STREET
COTTAGE GROVE, OREGON

revisions:

date: JAN. 13, 2023
drawn by: KS
designer: NP
project no: 22-001H

SECTION VIEWS

sheet:

C-0

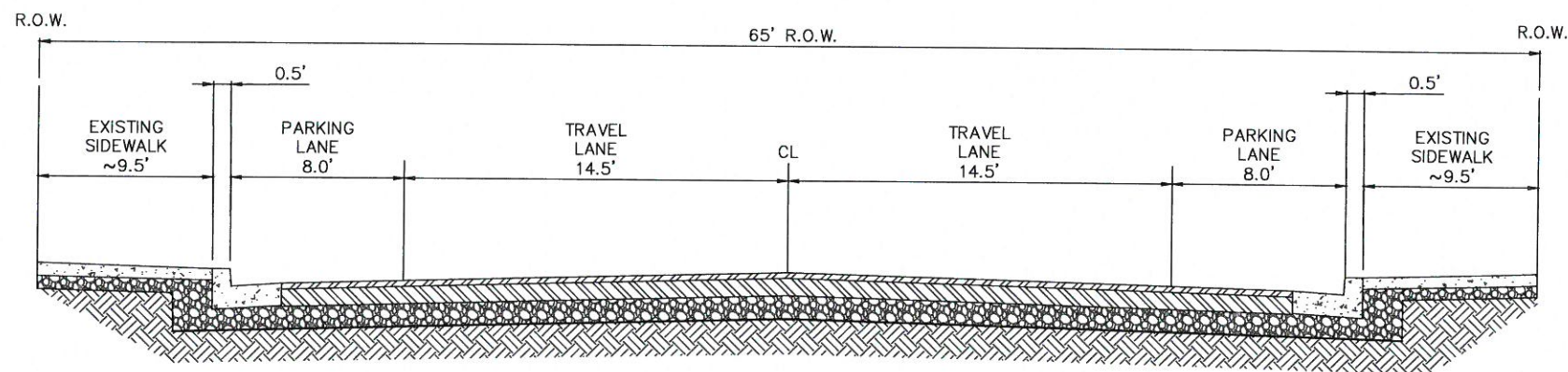

1 EXISTING SECTION
SCALE: N.T.S.

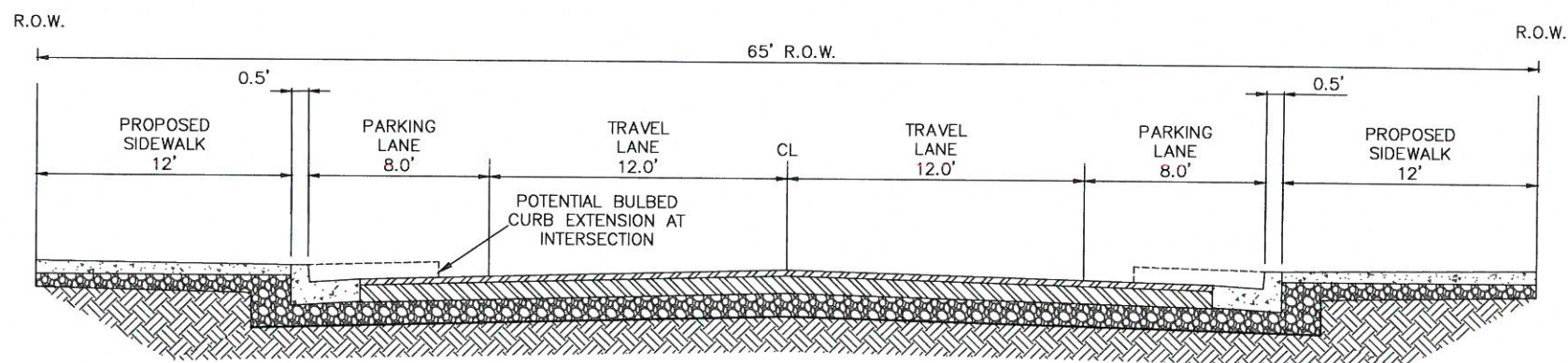

2 PROPOSED SECTION - PREFERRED
SCALE: N.T.S.

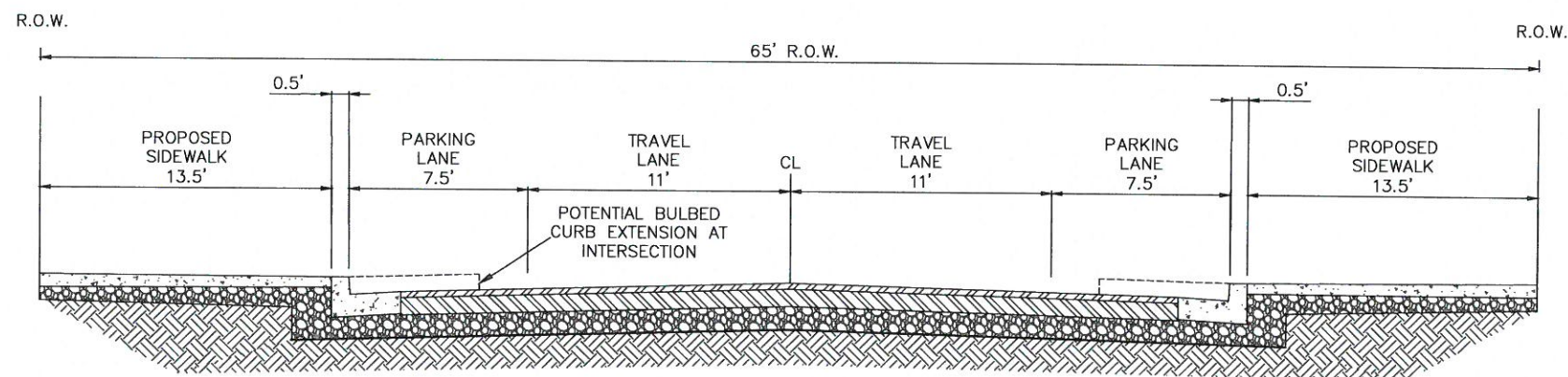

3 PROPOSED SECTION - ALTERNATE
SCALE: N.T.S.

LAYOUT OF IMPROVEMENTS IS PRELIMINARY AND SUBJECT TO NECESSARY ADJUSTMENTS BASED ON VARIABLES DURING THE DESIGN PROCESS.

PRELIMINARY
NOT FOR CONSTRUCTION

project title:

EAST MAIN STREET IMPROVEMENTS

E MAIN STREET & S 6TH STREET
COTTAGE GROVE, OREGON

revisions:

date: JAN. 06, 2023
drawn by: KS
designer: NP
project no: 22-001H
SECTION VIEWS

sheet: **C-0**

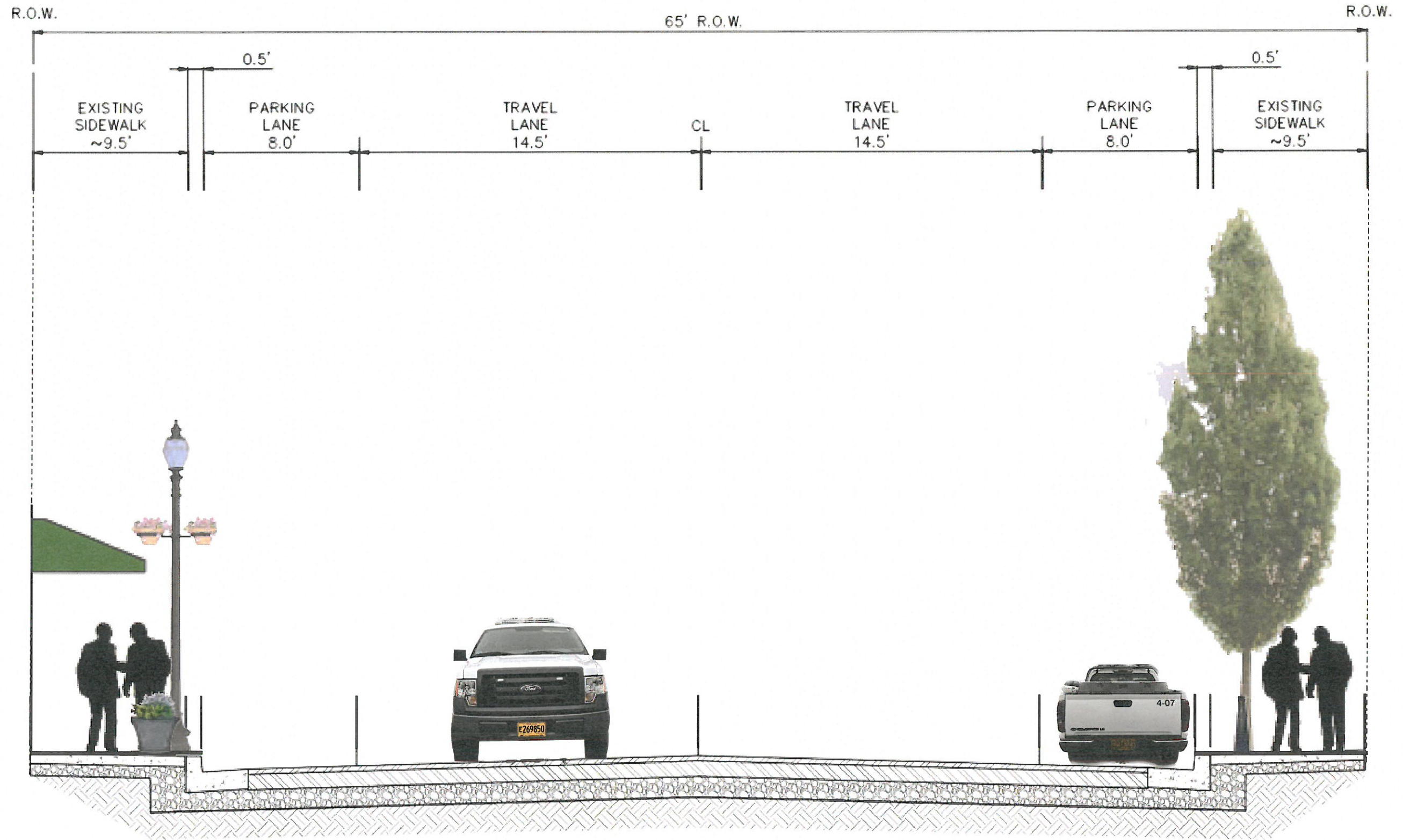

1 **EXISTING SECTION**
SCALE: N.T.S.

2: 2023/01/06 10:00 AM 310 5th Street Cottage Grove, OR 97477 541.746.0637

PRELIMINARY
NOT FOR CONSTRUCTION

project title:

EAST MAIN STREET IMPROVEMENTS

E MAIN STREET & S 6TH STREET
COTTAGE GROVE, OREGON

revisions:

date: JAN. 06, 2023
drawn by: KS
designer: NP
project no: 22-001H

SECTION VIEWS

sheet: **C-0**

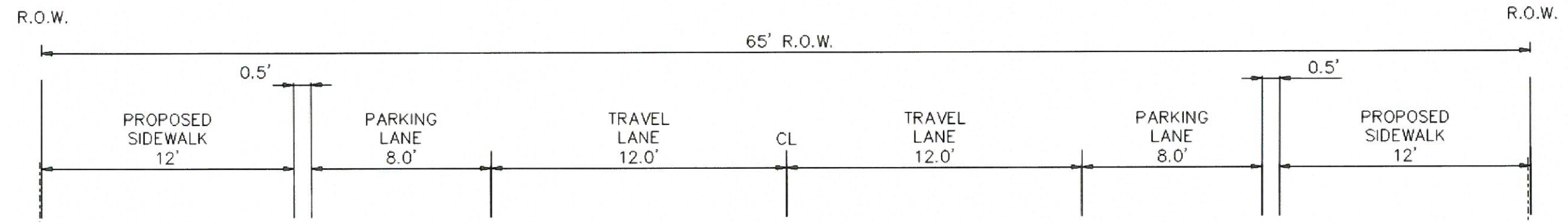

2 PROPOSED SECTION - PREFERRED
SCALE: N.T.S.

23_V:\2023\22-001H Cottage Grove Main St\Drawings\22-001H Main Street Layout.dwg 1/6/2023 10:10 AM 6052176

PRELIMINARY
NOT FOR CONSTRUCTION

project title:

EAST MAIN STREET IMPROVEMENTS

E MAIN STREET & S 6TH STREET
COTTAGE GROVE, OREGON

revisions:

date: JAN. 06, 2023
drawn by: KS
designer: NP
project no: 22-001H

SECTION VIEWS

sheet: **C-0**

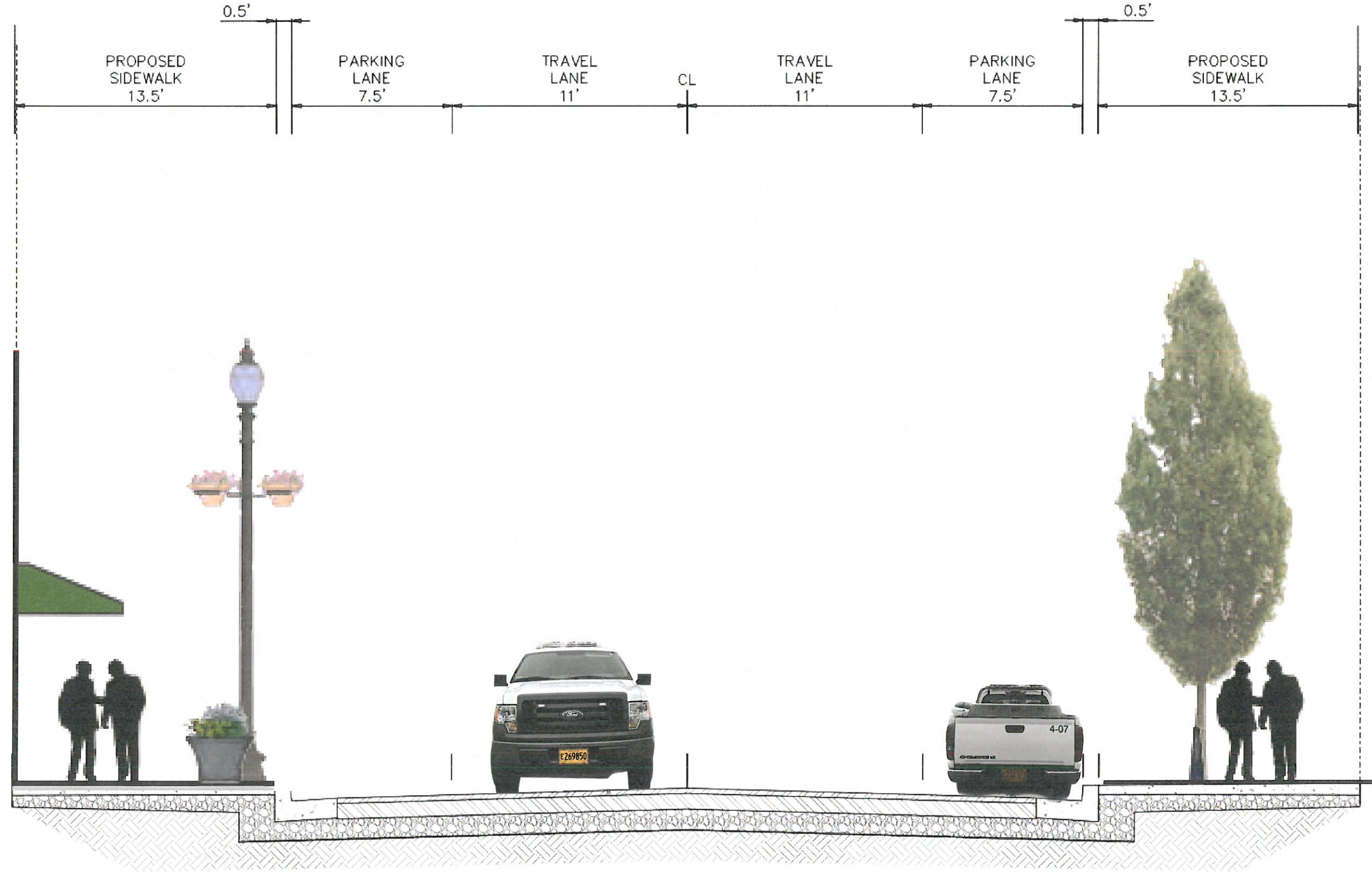
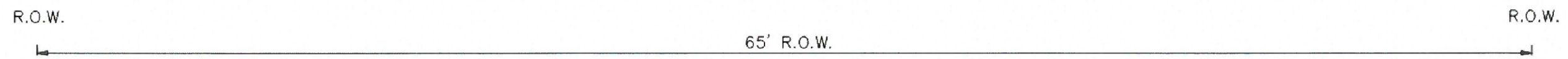

3 PROPOSED SECTION - ALTERNATE
SCALE: N.T.S.

23_1003131-001H Cottage Grove Main St Improvements 1/6/2023 10:10 AM GDA/HL